



# INSTALLATION INSTRUCTIONS

## 2021+ FORD BRONCO ROOF POD MOUNT KIT



### PRODUCT INCLUDES:

- (2) Mount #46729
- \*Lights sold separately

### RECOMMENDED TOOLS:

- 10mm Socket
- 13mm Socket and Wrench
- Blue Thread Locker

THANK YOU FOR PURCHASING RIGID INDUSTRIES' PRODUCTS FOR YOUR VEHICLE.

Please read through all of these Instructions and tips before proceeding with the installation. We do our best to provide a simple installation process for all applications however a professional installation is always recommended.

### IMPORTANT

Always disconnect any power sources connected to your vehicle before servicing fuses or electrical systems.

### STEP: 1

Locate the factory accessory ready covers above the windshield.

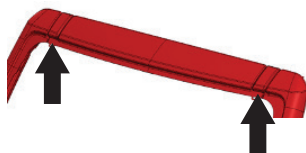

To remove, reach around the back side of the cover and depress the black tab and pull the cover outward.

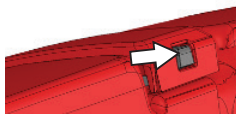

Remove the two nuts on each side with a 10mm socket. Do not reuse these nuts. Supplied replacement nuts have a serrated locking feature. Then remove the black retainer for the covers.

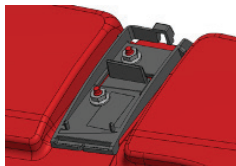

### STEP: 2

With the retainer removed, install the rubber isolation pads.

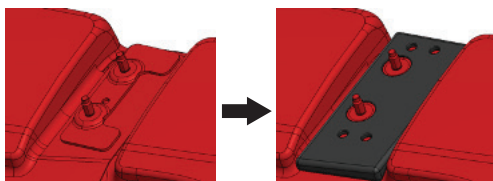

# RIGID<sup>®</sup> INSTALLATION INSTRUCTIONS

## STEP: 3

Install the new covers to the passenger and driver side brackets with the supplied self-tapping screws.

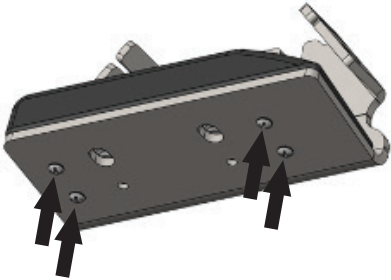

Install the supplied U-Nuts onto the brackets as shown.

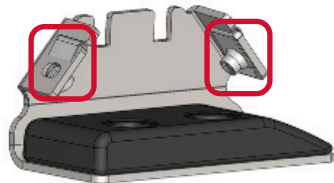

## STEP: 4

The image on the left with the bare bracket shows the slotted adjustment. Install with the studs centered in the slots, adjust placement if needed for the main bracket for mounting pods. Install the new supplied serrated nuts with a 10mm socket loosely.

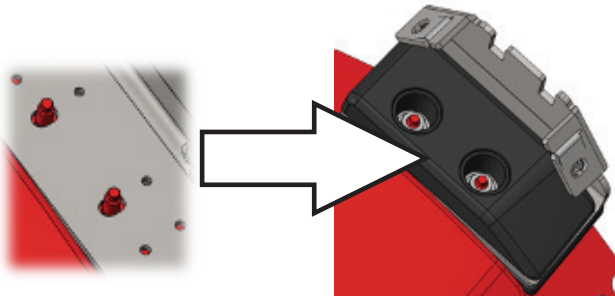

## STEP: 5

The main bracket for mounting pods has two bolt patterns for 6 or 8 pods. The square holes marked above with a circular hole indicates spacing for 8 pods.



Install aluminum truss bracket underneath the main steel bracket as shown below.

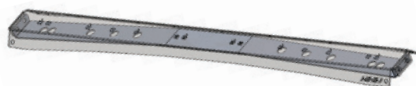

Proceed to install the carriage bolts as shown. Loosely thread on the nyloc nuts.

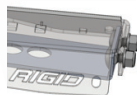

# RIGID INSTALLATION INSTRUCTIONS

## STEP: 6

After the carriage bolts are installed on the ends of the brackets, proceed to install the two pods in the center of the mounts.

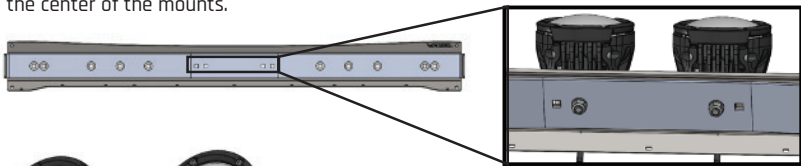

Supplied shorter carriage bolts can be installed two ways as shown. Having the nyloc nut on top allows for adjustments after installation of the entire kit. Use a 13mm socket or wrench to install the carriage bolts.

If the nyloc nuts are installed underneath, there are provisions for using sockets to access the nuts.

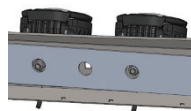

After installing the pods, your assembly should resemble this image below.

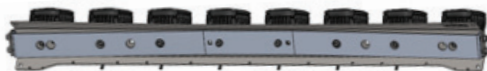

## STEP: 7

With two people, test fit the newly assembled rack assembly and place it onto the side brackets.

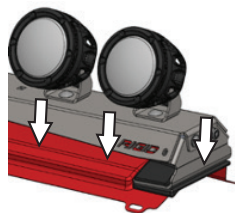
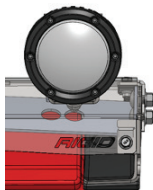

When lowering down the rack assembly, ensure the rack assembly sandwiches the side bracket as shown.

The side brackets are slotted to capture the carriage bolts. If this easily fits, remove the rack assembly and tighten the two serrated nuts on the factory accessory studs with blue thread locker. Afterward, install the caps for the covers.

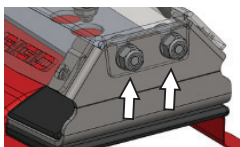

# RIGID<sup>®</sup> INSTALLATION INSTRUCTIONS

## STEP: 8

Reinstall the rack assembly as before however, do not tighten the outer carriage bolts yet.

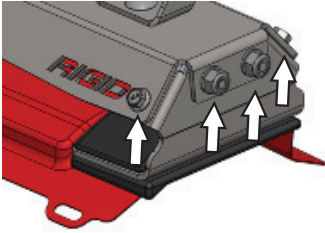
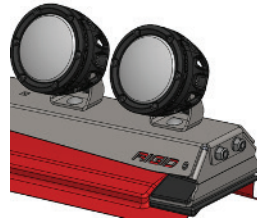

Install the corner M6X1.0 bolts with a 10mm socket loosely with blue thread locker. Once all corner bolts are installed, tighten 4 side carriage bolts and the corner bolts.

## STEP: 9

Use these holes for wire management (Rectangle holes made to accommodate zip ties).

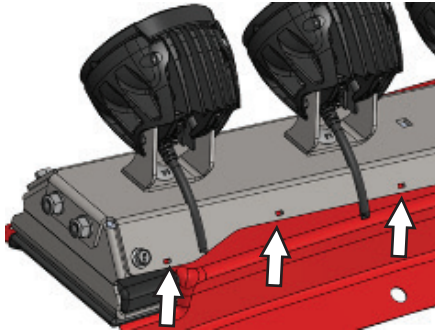

Wiring: Wire your lights according to the instructions included with the light. Take care to avoid any heat sources and sharp or abrasive surfaces.

Your installation is now complete.  
**Welcome to the Rigid Nation!**

### WARRANTY INFORMATION

For warranty information, visit [www.rigidindustries.com/about/warranty](http://www.rigidindustries.com/about/warranty) 779 N Colorado St, Gilbert, AZ 85233 • 855-760-5337  
[www.rigidindustries.com](http://www.rigidindustries.com)

RIGID, 360-Series, and Rigid Industries are registered and/or common law marks owned by JST Performance, LLC, a Delaware limited liability company d/b/a Rigid Industries.

11-14109-A