



INSTALLATION INSTRUCTIONS



TOYOTA OVERLAND CAT-BACK PART NO. 19585

BILL OF MATERIALS:

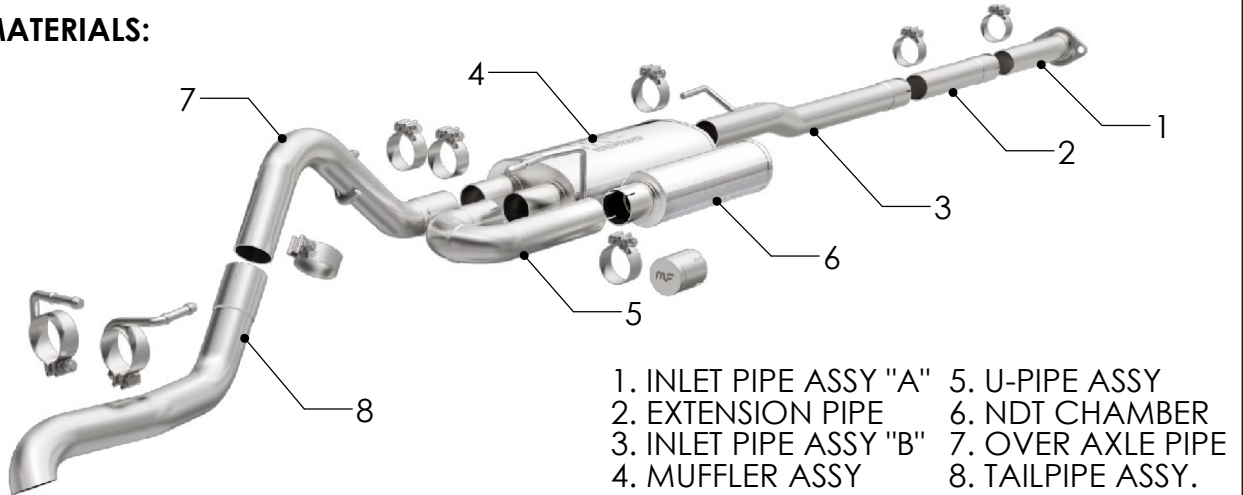

WEAR SAFETY GLASSES



READ INSTRUCTIONS THOROUGHLY BEFORE INSTALLING PRODUCT



SHOP SUPPLIES:
SPRAY LUBRICANT

To ease removal of existing exhaust components (especially on older vehicles) spray penetrating lubricant on all fasteners and hangers/insulators that will be loosened or removed and let soak before disassembly.

HARDWARE KIT:

- 1. [7] 2.50" Torca Clamp
- 2. [1] Hanger Assy 05-11
- 3. [1] Hanger Assy 12-15
- 4. [1] Pipe Cap MF Logo
- 5. [1] MF Decal
- 6. [1] MF Patch

MINIMUM REQUIRED TOOLS:



13mm



Hanger Tool (Or Pry Bar)

MAGNAFLOW RECOMMENDS PROFESSIONAL INSTALLATION ON ALL THEIR PRODUCTS



WARNING: When working on, under, or around any vehicle exercise caution. Please allow the vehicle's exhaust system to cool before removal, as exhaust system temperatures may cause severe burns. If working without a lift always consult vehicle manual for correct lifting specifications. Always wear safety glasses and ensure a safe work area. Serious injury or death could occur if safety measures are not followed.

ATTENTION: Always install any supplied band or U-bolt clamps to the proper torque specifications of 40-45 ft-lb for band clamps and 30-35 ft-lb for U-bolt clamps. Over tightening will result in the clamps breaking and will NOT be warranted by MagnaFlow.

MAGNAFLOW: 1901 Corporate Centre Dr - Oceanside, CA 92056 | 1(800)990-0905
 Technical Support: 1(800) 959-9226 | Email: moreinfo@magnaflow.com

INSTALLATION INSTRUCTIONS

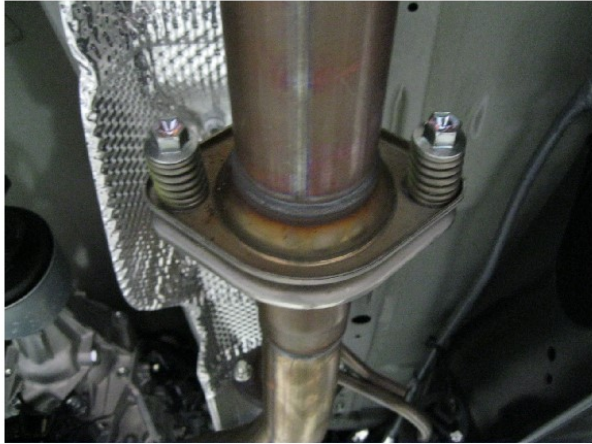

Step 1: To remove the OE exhaust system, unfasten the hardware at the inlet flange (Retain fasteners to be re-used).

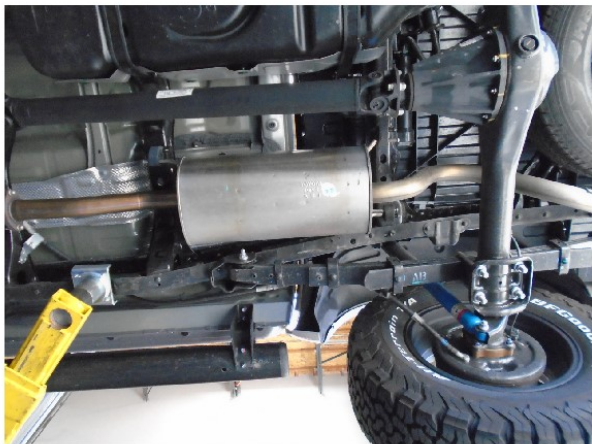

Step 2: Working front to rear, disengage all welded hangers from the rubber insulators and remove the system. (Retain the rubber insulators as they will be needed to mount the new MagnaFlow system.)

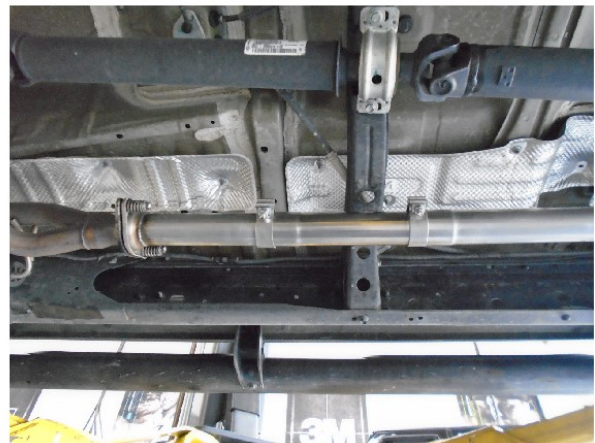

Step 3: Begin Installing the new system by attaching Inlet Pipe "A" to the vehicle using the OE Fasteners. **-NOTICE-** At this point On Crew Cab Long Bed vehicles you will need to add the provided 14" Extension Pipe using the 2.50" clamp.

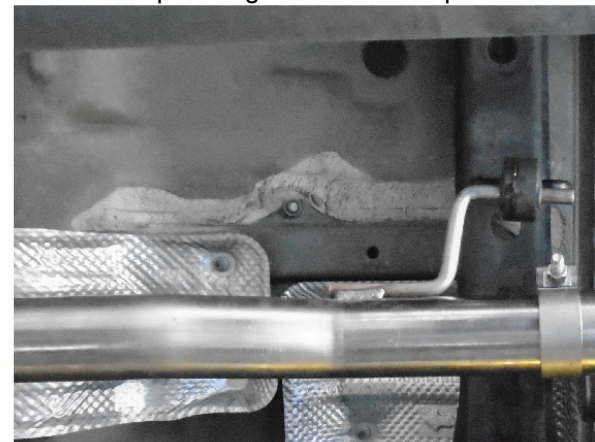



Step 4: Next, attach Inlet Pipe "B" to Inlet Pipe "A" (or the Extension Pipe) using a provided 2.50" Clamp and fit the hanger into the rubber insulator.

MAGNAFLOW: 1901 Corporate Centre Dr - Oceanside, CA 92056 | 1(800)990-0905
Technical Support: 1(800) 959-9226 | Email: moreinfo@magnaflow.com

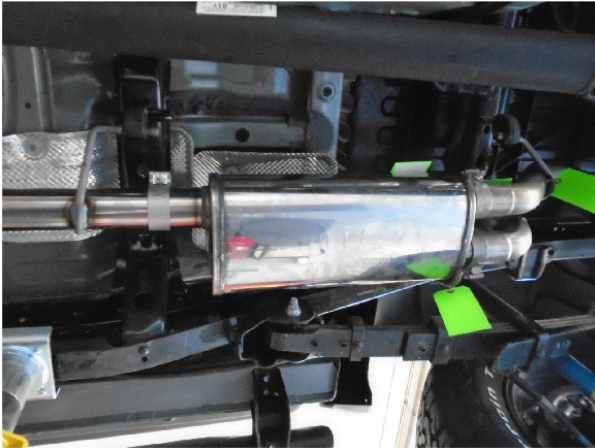
INSTALLATION INSTRUCTIONS



Step 5: Next attach the Oval Muffler to the Inlet Pipe with the supplied 2.50" clamp. This exhaust system is configured to allow the user to tune the sound. For a more moderate exhaust sound install the U-pipe Assy and the 4.00" NDT Chamber (as shown) using the supplied 2.50" clamps. For a more aggressive sound see configuration chart below.

| | |
|---|--|
|  | MODERATE TONE: U-PIPE WITH NDT CHAMBER |
|  | AGGRESSIVE TONE: U-PIPE WITH PIPE CAP |
|  | MOST AGGRESSIVE TONE: ONLY PIPE CAP |

NOTICE: For visual representation only, see photo's for actual install.



Step 6: Attach the Over Axle Pipe to the Muffler Assembly as shown using the provided 2.50" clamp and the OE rubber insulator.

INSTALLATION INSTRUCTIONS



Step 7: Before installing the Tailpipe Assembly loosely fit the appropriate Hanger Clamp Assembly from the rear of the tailpipe. Hanger Assemblies are divided by year spread, 2005-2011 and 2012 -2015. Once fitted, install the Tail Pipe Assembly to the Over Axle Assembly using the supplied 2.50" clamp and fit the Hanger Assembly into the rubber insulator.



Step 8: Once a final position has been chosen for the new exhaust system, evenly tighten all clamps from front to rear using the torque specifications on page one of the instructions. Inspect all fasteners after 25-50 miles of operation and re-tighten if necessary.