



INSTALLATION INSTRUCTIONS



2019 FORD RANGER 2.3L

PART NO. 19451

BILL OF MATERIALS:

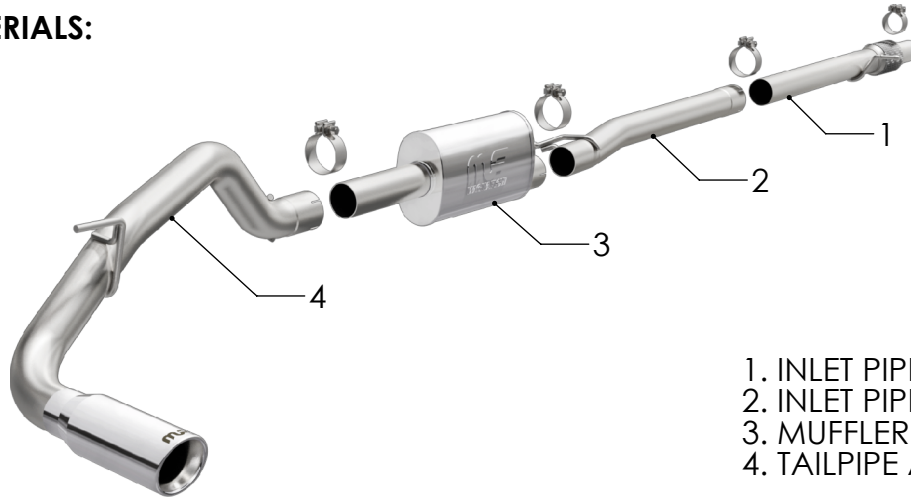

- 1. INLET PIPE ASSY
- 2. INLET PIPE EXTENSION ASSY
- 3. MUFFLER ASSY
- 4. TAILPIPE ASSY



WEAR SAFETY GLASSES



READ INSTRUCTIONS THOROUGHLY BEFORE INSTALLING PRODUCT



SPRAY LUBRICANT

To ease removal of existing exhaust components (especially on older vehicles) spray penetrating lubricant on all fasteners and hangers/insulators that will be loosened or removed and let soak before disassembly.

HARDWARE KIT:

- 1. [3] 3.00" Clamp
- 2. [1] 2.50" Clamp

MINIMUM REQUIRED TOOLS:



13mm, 15 mm



Hanger Tool (Or Pry Bar)

MAGNAFLOW RECOMMENDS PROFESSIONAL INSTALLATION ON ALL THEIR PRODUCTS



WARNING: When working on, under, or around any vehicle exercise caution. Please allow the vehicle's exhaust system to cool before removal, as exhaust system temperatures may cause severe burns. If working without a lift always consult vehicle manual for correct lifting specifications. Always wear safety glasses and ensure a safe work area. Serious injury or death could occur if safety measures are not followed.

ATTENTION: Always install any supplied band or U-bolt clamps to the proper torque specifications of 40-45 ft-lb for band clamps and 30-35 ft-lb for U-bolt clamps. Over tightening will result in the clamps breaking and will NOT be warranted by MagnaFlow.

MAGNAFLOW: 1901 Corporate Centre Dr - Oceanside, CA 92056 | 1(800)990-0905
Technical Support: 1(800) 959-9226 | Email: moreinfo@magnaflow.com

INSTALLATION INSTRUCTIONS

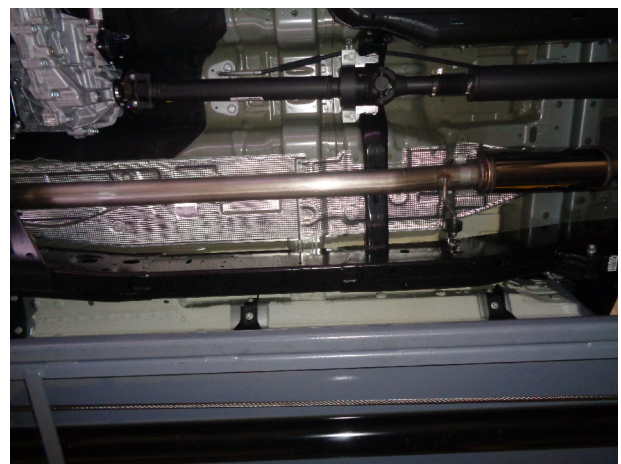
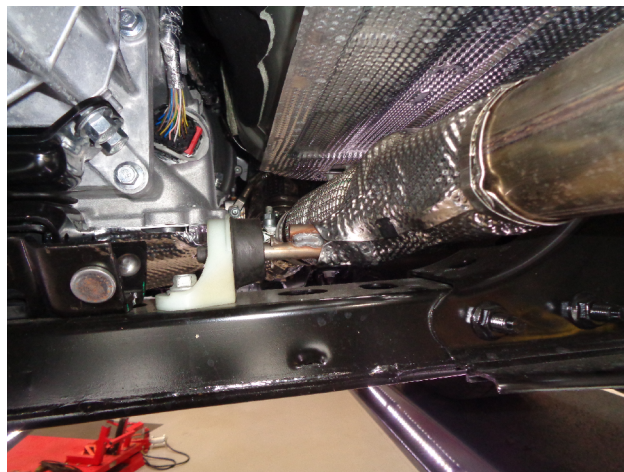
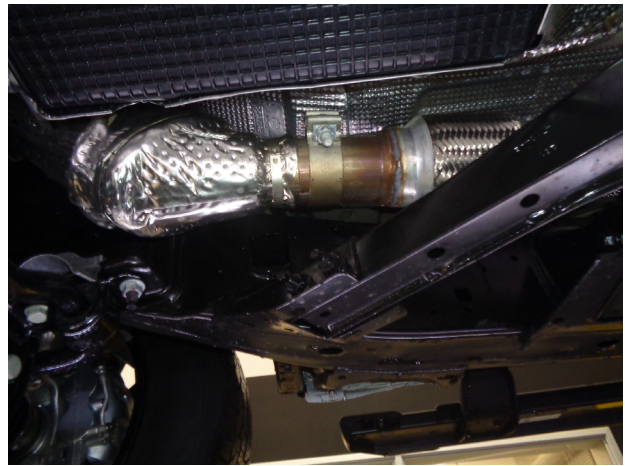
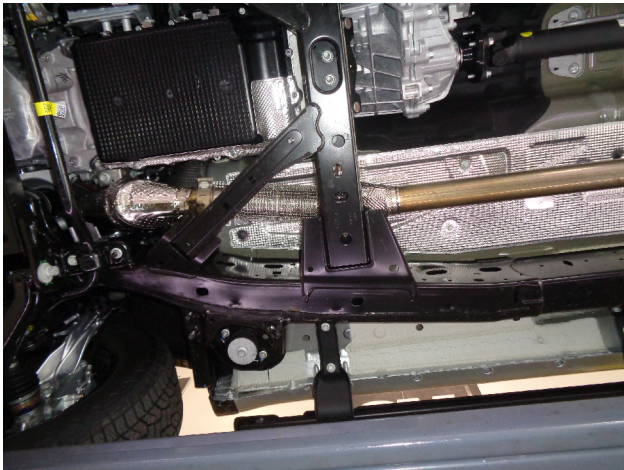

Step 1. To remove the OEM exhaust system, you can then disengage the welded hangers from the rubber insulators and remove the tailpipe assy. Unfasten the clamp attaching the OEM inlet pipe assembly to the catalytic converter. Do not damage or discard the inlet pipe clamp or rubber insulators as they will be re-used to mount the new system. Disengage the inlet pipe assembly hanger and remove the exhaust from the vehicle.

Step 2. To begin, fasten the Inlet pipe assembly to the outlet of the OE system using the OE clamp assembly and by fitting the welded hanger into the rubber insulator (Leave all clamps and fasteners loose for final adjustment of the complete system.)

INSTALLATION INSTRUCTIONS

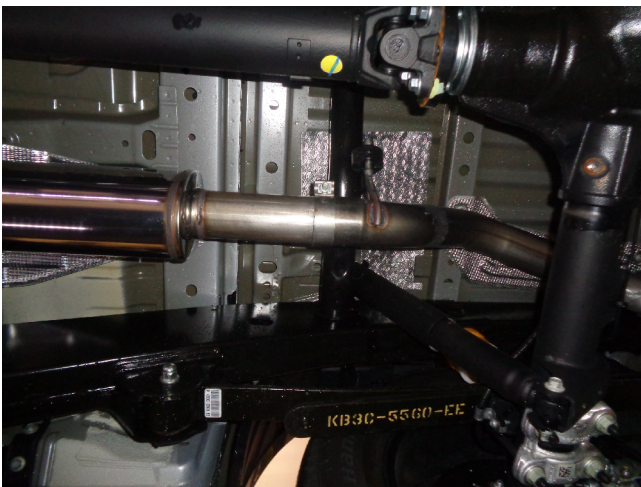
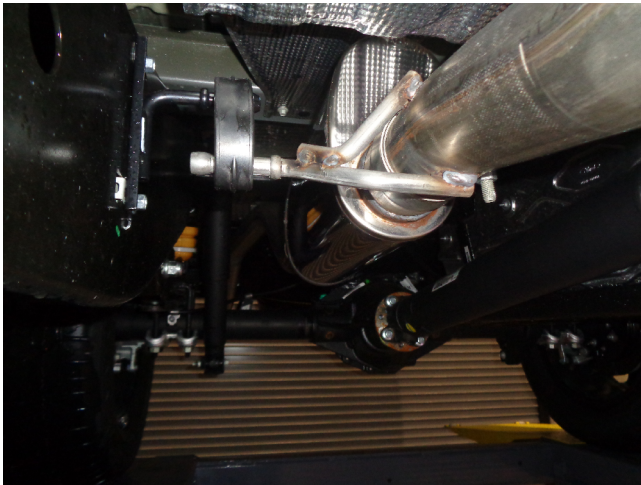

Step 3. Next loosely attach the Tailpipe Assembly to the Muffler Assembly using the supplied clamp. Engage the welded hanger to the rubber insulator.

Step 4. Once a final position has been chosen for the new exhaust system, evenly tighten all clamps from front to rear using the torque specifications on page one of the instructions. Inspect all fasteners after 25-50 miles of operation and re-tighten if necessary.