



**IMPORTANT WARRANTY & INSTALLATION  
INSTRUCTIONS ATTACHED**

*Please Forward All Attached Information to Consumer  
Warranty Not Valid Unless Returned to CORSA Performance*

**We ask that you take a few moments to complete our warranty registration form:**

TO ACTIVATE YOUR LIMITED LIFETIME WARRANTY GO TO:  
**[CORSAPERFORMANCE.COM/WARRANTY](http://CORSAPERFORMANCE.COM/WARRANTY)**



**For Full-Color Installation Instructions, Please Visit:  
[CORSAPERFORMANCE.COM](http://CORSAPERFORMANCE.COM) and Search by Part Number**

Please be sure to review the enclosed instructions prior to beginning the installation process. If you have any questions about the enclosed parts, instructions or encounter a problem during installation:  
**CALL CORSA PERFORMANCE TECHNICAL ASSISTANCE AT 800.486.0999**

Please take time to read and understand these installation instructions.

CORSA recommends that the installation of this system be performed by a qualified service center or professional muffler installer who has the necessary equipment, tools and experienced personnel. However, if you decide to perform this install, the use of a hoist and an additional person will be required.

**CAUTION:** Never work on a hot exhaust system. Allow time for the vehicle to cool. Always wear eye protection when working under a vehicle.

### Recommended Tools:

- 3/8" drive ratchet
- 3/8" drive 13mm shallow socket
- 3/8" drive 15mm deep socket
- Small, flat head screw driver
- Chain style pipe cutter
- Grommet pullers
- Spare tire removal kit
- Soap and water solution
- Torque Wrench
- Safety glasses

**Please confirm that all parts are present according to the bill of materials before beginning the installation.**

If something is missing call Tech Support at 1- 800-486-0999

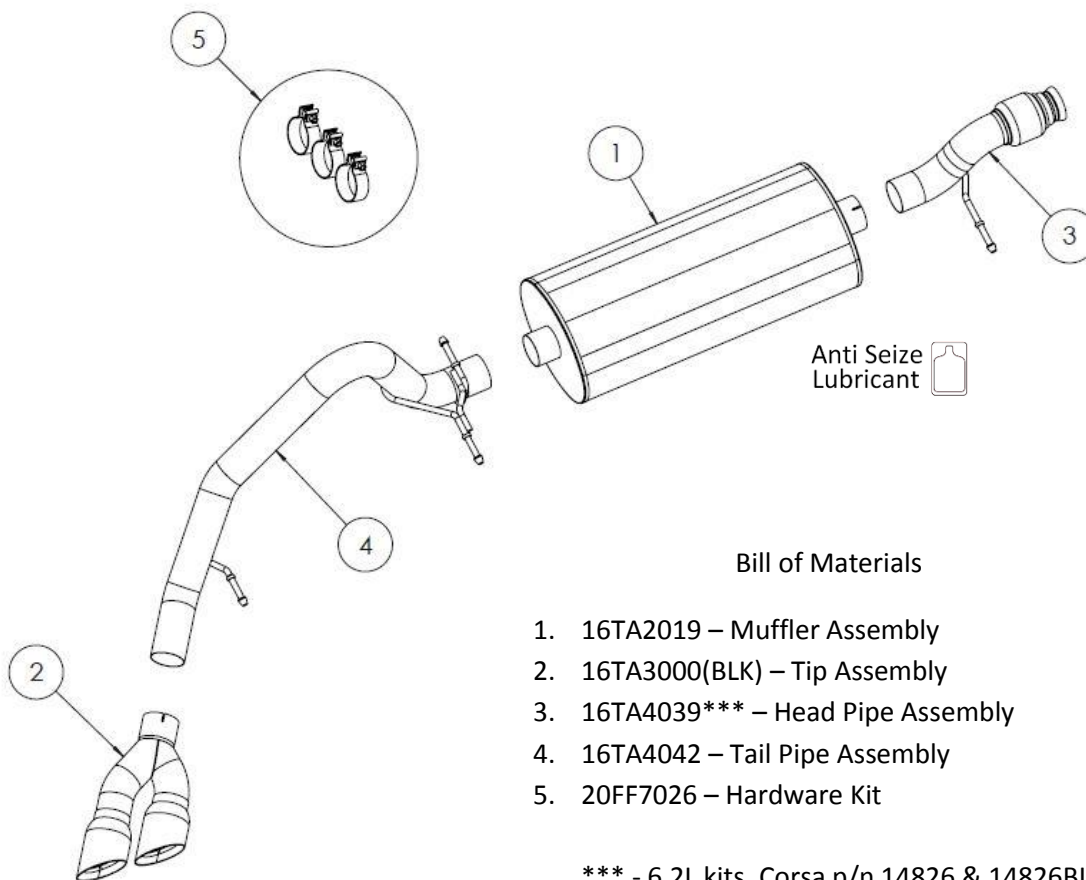

#### Bill of Materials

1. 16TA2019 – Muffler Assembly
2. 16TA3000(BLK) – Tip Assembly
3. 16TA4039\*\*\* – Head Pipe Assembly
4. 16TA4042 – Tail Pipe Assembly
5. 20FF7026 – Hardware Kit

\*\*\* - 6.2L kits, Corsa p/n 14826 & 14826BLK use head pipe p/n 16TA4049, **NOT** 16TA4039 \*\*\*

### **Factory Exhaust System Removal:**

1. Use a small, flat head screwdriver to carefully pry off the spare tire mechanism cover plate in the rear bumper. Insert the ignition key to remove the locking mechanism to gain access to the spare tire removal system. **(Fig. A)**
2. Using the spare tire removal kit from your vehicle, insert the square end into the spare tire removal shaft, then turn the wrench counter-clockwise to lower the spare tire. **(Fig. B)**
3. Remove the two bolts securing the heat shield using a 15mm socket and ratchet. **(Fig. C & D)**
4. Place a chain style cutter around the tail pipe about 1-2" behind the most rearward hanger on the front half of the axle pipe. Cut the tail pipe at this location. **(Fig. E & F)**
5. Remove the grommet from the tail pipe hanger (on the cut portion) using grommet pullers or a similar device. **(Fig. G)**  
**Note: Using a soapy solution on the grommet holes will make the job easier.**
6. Carefully remove the tail pipe section from the vehicle by lifting the tail pipe over the rear axle and backwards under the rear bumper. **(Fig. H)**
7. Use a 13mm shallow socket and ratchet to loosen the spherical clamp on the head pipe. Remove the hanger from the grommet in front of the muffler using grommet pullers or similar device. **(Fig. J & K)**
8. Remove the hangers from the grommets behind the muffler. Remove the head pipe at the spherical connection to free the muffler section from the vehicle. **(Fig. L, M, & N)**
9. Use the small, flat head screwdriver to gently pry up the tab on the head pipe and remove the factory spherical clamp. Set aside the clamp to be reused during the installation process. **(Fig. P)**

**REMOVAL PICTURES ON NEXT PAGE** 

## Factory Exhaust Removal Pictures



Fig. A



Fig. B



Fig. C



Fig. D

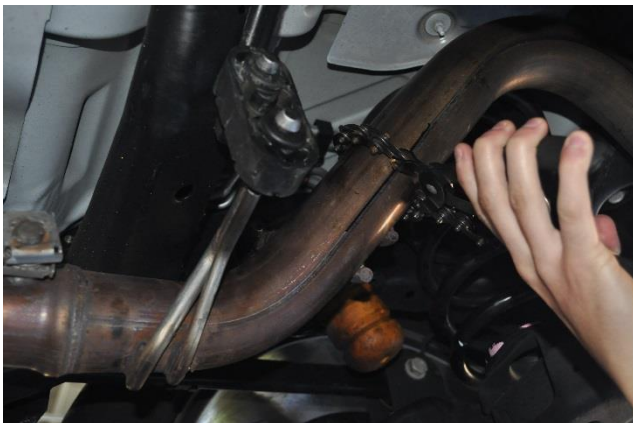

Fig. E

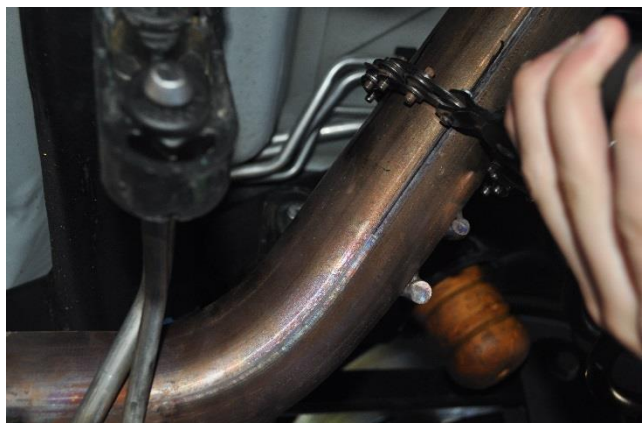

Fig. F

REMOVAL PICTURES CONTINUED ON NEXT PAGE 

## Factory Exhaust Removal Pictures

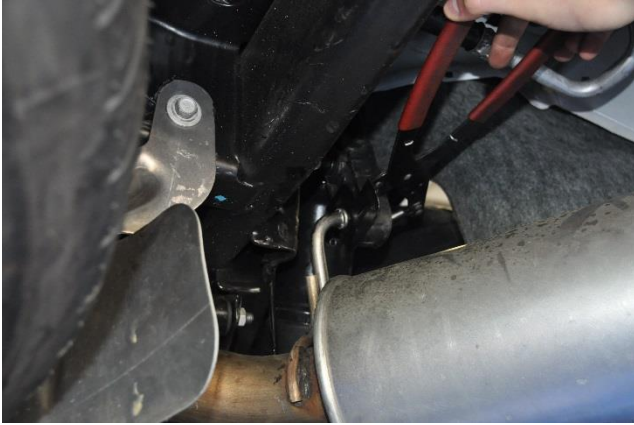

Fig. G



Fig. H



Fig. J



Fig. K



Fig. L



Fig. M

**REMOVAL PICTURES CONTINUED ON NEXT PAGE** 

## Factory Exhaust Removal Pictures



Fig. N

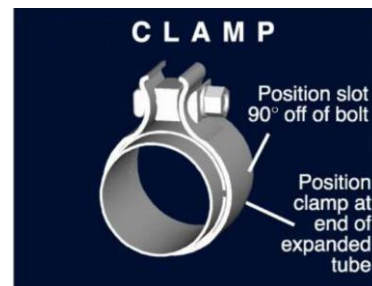

Fig. P

### Installation of CORSA Exhaust System:

**NOTE:** Apply the anti-seize lubricant (*supplied*) to the threads **ONLY** of all the clamps and flange bolts. Failure to follow this procedure can cause nuts to seize on clamps and potentially destroy threads. After applying anti-seize lubricant, be sure to thoroughly clean your hands, as lubricant will tarnish stainless steel. All clamps should be tightened using a properly calibrated Torque Wrench. Using an air impact gun will damage the clamp and reduce its ability to effectively seal the joint. It may also cause the joint to separate, thereby causing damage to your exhaust system and to your vehicle.

**NOTE:** Align all clamps so that the center of the clamp bolt is 90 degrees from the notch in the pipe. (See Fig. CLAMP)



1. Remove all system components from the shipping box, including the clamps.
2. Locate the CORSA head pipe assembly and the factory spherical joint retained from the removal process. Rotate the head pipe until the hanger shoulder is parallel to the ground, then snug the clamp at the spherical connection using a shallow 13 mm socket and ratchet. (Fig. Q & R) **Note:** Using a soapy solution on the grommet hole will make the job easier.
3. Slide the supplied 3" TORCA clamp over the inlet of the CORSA muffler. Make sure the muffler is oriented so the drain hole is facing down, then slide the muffler onto the head pipe and snugly tighten the clamp with a 15mm socket and ratchet. (Fig. S & T)
4. From the front side of the vehicle, slide the CORSA tail pipe over the axle towards the rear, passing the hanger through the voids in the spring. Slide the supplied 3" TORCA clamp over the inlet of the CORSA tail pipe before inserting the pipe onto the muffler outlet. Install each hanger into the factory grommets. Rotate the tail pipe to adjust the height of the tail pipe outlet (Note: temporarily mocking up the tip assembly on the end of the tail pipe may aid in this step). Snugly tighten the clamp using a 15mm socket and ratchet. (Fig. U, V, W, X, and Y) **Note:** Using a soapy solution on the grommet holes will make the job easier.
5. Slide a 3" TORCA clamp over the tip assembly inlet, and place the tip onto the end of the tail pipe. Adjust assembly inlet on tail pipe so that tips match bevel of the rear quarter panel. Rotate the tip assembly until tips have equal clearance to the side of the rear bumper cover. Snugly tighten the clamp at this time using a 15mm socket and ratchet. (Fig. Z, AA, & BB) **NOTE:** Tail pipe rotation varies by vehicle.
6. Adjust all CORSA components to attain clearance to surrounding parts. Starting from the front of the CORSA exhaust system, tighten all TORCA clamps to 45 ft-lbs and all spherical clamps to 21 ft-lbs using a torque wrench.
7. Reinstall the heat shield using a 15mm socket and ratchet. Replace the spare tire to pre-removal condition, and replace the lock and cover plate in the rear bumper. (Fig. CC & DD)
8. **It is strongly suggested that all clamps be checked and tightened after road testing the vehicle, once the system has cooled.**

**NOTE:** During cold weather start-ups, you may experience an exhaust sound that is deeper and louder in tone than usual. This is temporary and will diminish to normal levels once your engine has reached its normal operating temperature.

**NOTE:** Immediately following the installation of your exhaust system, you may experience a trace of smoke after initial start-up. DO NOT be alarmed. The smoke is caused by the burning of a small amount of forming oil residue used in the manufacturing process.

## CORSA Exhaust Installation Pictures



Fig. Q



Fig. R



Fig. S

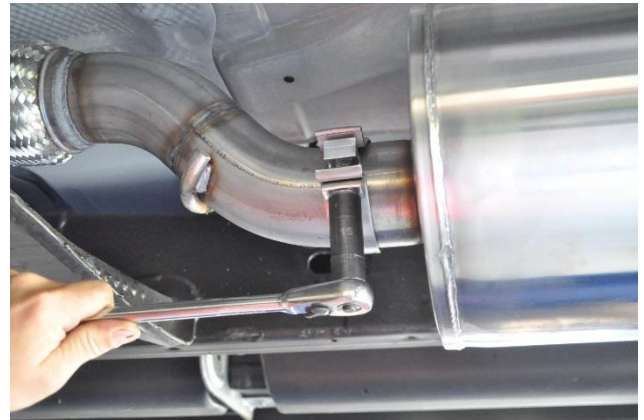

Fig. T



Fig. U



Fig. V

**INSTALLATION PICTURES CONTINUED ON NEXT PAGE** 



## CORSA Exhaust Installation Pictures:



Fig. W



Fig. X



Fig. Y



Fig. Z

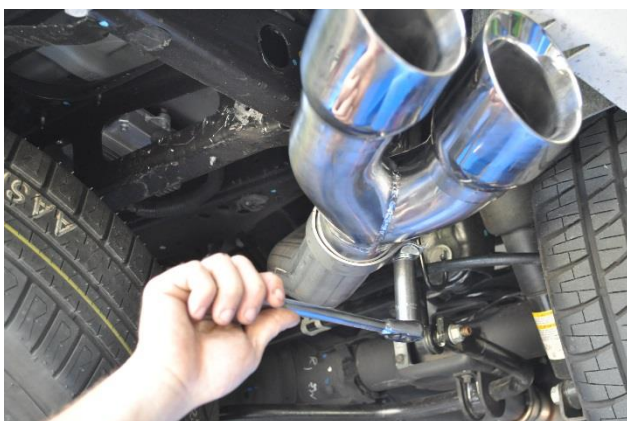

Fig. AA



Fig. BB

**INSTALLATION PICTURES CONTINUED ON NEXT PAGE** 

## CORSA Exhaust Installation Pictures:



Fig. CC



Fig. DD